



TGF

THE
ERGIT 100
SERIES

ERGIT 100: A NEW TRACTOR CONCEPT

Antonio Carraro SPA produces specialized tractors for professionals wishing to experience the emotion of owning something unique and precious that is guaranteed by a one-hundred-year-old brand at the cutting-edge of "Italian Style".



The Ergit 100 series is a new tractor concept. It is the outcome of a construction philosophy based on engineering simplification and the selection of top quality components; factors that allow the company to give these models a 2-year warranty, which can be extended up to 4 years. The care taken in design assures a pleasant and relaxed driving experience. It is not only attractive, but also performance enhancing as it allows for total operator visibility in all directions and ease when working in small spaces. The engines, with power outputs from 70 to 100 hp, offer exceptional torque and power levels combined with lower fuel consumption. The bodywork is painted with environmentally-friendly hydrosoluble enamels. Each technical solution is the result of choices that are based on socio-environmental benefits in terms of reduced pollution and noise levels.



**THE
ERGIT100
SERIES**





CARRARO

T6F 9500

T6F 10500

CARRARO

PROTEZIONE PERSONALE INTEGRATA

TGF: the specialized tractor par excellence



The **TGF** tractor, featuring a super-low profile and unequal wheels, was designed to work nimbly between narrow rows and perform tight turns thanks to its small front wheels. Operators can choose between as many as 16 combinations in order to personalize their TGF and assure exceptional performance on any type of terrain. TGF, a powerful but compact vehicle, remains stable and perfectly balanced even when fitted with the most demanding equipment. It is ideal for working in thick orchards, canopy vineyards, greenhouses, and even on steep terrain with a steep horizontal slope.

On request, the TGF can be fitted with the classical Starlight cab or with one of the three types of super-low profile Protector cabins, which combine maximum insulation with comfort and visibility. The streamlined and functional design of the cabs is the outcome of years of work at the Antonio Carraro research and development laboratories.



TGF



**DESIGN
TECHNOLOGY
INNOVATION**



MULTI-FUNCTIONALITY: all-in-one

The use of TGF can be changed thanks to the integrated lifting, hydraulic system, and PTO assembly. All of which make it possible to rapidly interchange the towing or frontal equipment that can also be mounted together.



MANY TRACTORS IN ONE



Shredders, sprayers, plows, tillers, trailers, grubbers, and listers are just some of the more common implements that can be used with the Ergit 100 series of tractors. The tires are interchangeable, as every type of terrain requires its own tire that can optimize tractor performance. Dimensions and clearances are other factors that can extend the multi-functionality of TGF by making it perfect for operating in tight spaces. The 60 litre (15,85 gal.) tank assures a high degree of operational autonomy.



TRADITIONAL TRACTOR



70% 30%



80% 20%

ACTRATOR



40% 60%



50% 50%

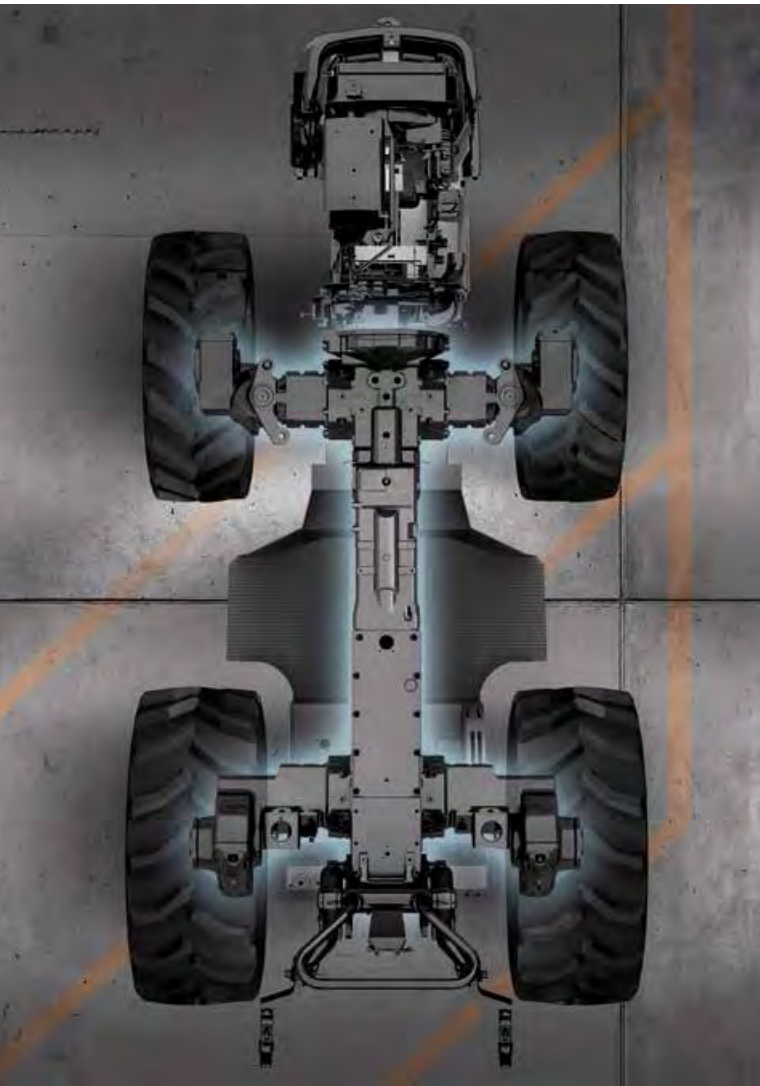

ACTIO™: the exclusive chassis designed by Antonio Carraro

ACTIO™, this Full Chassis with Oscillation is comprised of a solid cast-iron chassis fixed to the axles and housing the tractor transmission. It features a central joint with a longitudinal oscillation of up to 15°. The two oscillating ends follow the contour of the terrain independently, thus assuring stability and traction at all times. The constant adherence of the tires to the ground allows engine power to be entirely transferred to the ground, thus increasing performance and safety. The ACTIO™ chassis requires a "projecting" engine configuration in order to assure a low center of gravity and an equal division of the weight of the tractor: 60% on the front axle; 40% on the rear axle. This is an ideal balance with implements attached as it distributes 50% of the weight on each axle.

ACTIO™

PLUS

- + **Stability:** low center of gravity with 4 wheel drive
- + **Safety:** peace of mind
- + **Comfort:** driving position centered over chassis oscillation
- + **Agility:** reduced turning radius
- + **Adherence:** equal division of weight
- + **Traction:** 4 drive wheels always firmly in contact with the ground



15°



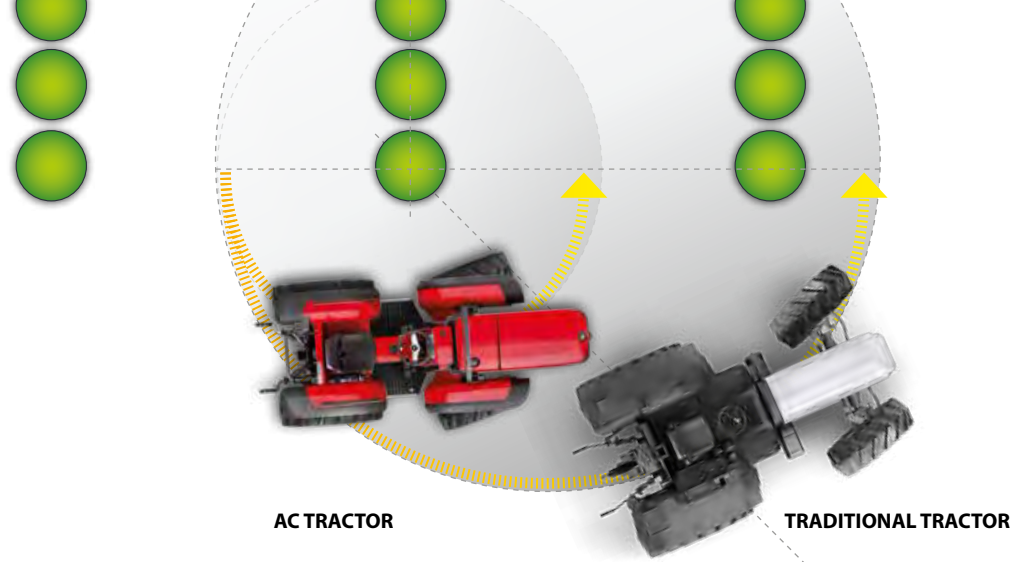

STEERING: precise and tight

The wheelbase and the small front wheels assure a tight turning radius and natural agility of the TGF between rows. To further reduce the turning radius, the steering brakes can be utilized, while accentuating the “superbend” effect obtained thanks to the double-acting constant velocity joints. The front wheel on the inside of the curve naturally increases the steering angle without the vehicle being allowed to stick. The smooth and sensitive hydroguide steering wheel assures precise maneuvering on steep slopes, in crossways movements, in narrow paths, among crop rows and in car parks.



PLUS

+ *Handiness: comfort*

Low center of gravity, constant contact, stability, efficient braking and protected driving position are just some of the “active” safety features not to mention the “passive” features, such as quality of components, design, and eco-friendly engines. The braking system is comprised of 4 hydraulically-controlled, self-adjusting disc brakes in an oil bath which assures emergency braking modularity and reliability even when the front axle is disengaged. The overall safety of the vehicle has allowed it to be approved for speeds of up to **40 Km/h (25 mph)**. The rear three-point lift features controlled position* and force of the implement, which optimizes adherence of the tractor, such that it always stays “glued to the ground”. The vehicle and its equipment follow the contour of the terrain without lifting, thus assuring maximum efficiency. The hydraulically controlled differentials lock at the rear and the front and rear in order to prevent slippage and assure that the tractor tires always have traction. The driving position is located at the center of the vehicle and features a roll-bar or cab approved to safety standards to ensure maximum operator protection.

40
Km/h



AC TRACTOR

TRADITIONAL TRACTOR

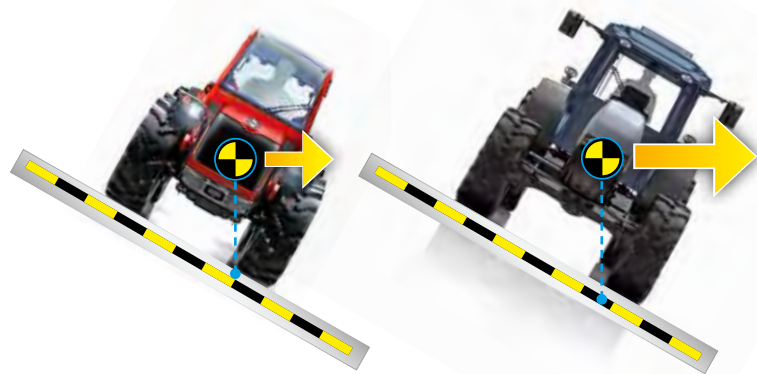

*optional mod. 9900



SAFETY: active and passive

ERGONOMICS & COMFORT

The tapered and racy design helps the tractor to maneuver in fields and increases operator visibility of the equipment and the surrounding terrain. The spacious driving position is easy to access and protects the operator.



The operating station is suspended on **silent-block**, which absorb vibrations and dampen noise. Thanks to the ACTIO™ Chassis, the driving position coincides with the center of oscillation of the tractor. Sideways jerking and stress are very limited and operator fatigue is reduced, even after many hours.

TGF 9900



TGF 10900



The on-board instrumentation is elegant, functional and intuitive: backlit anti-reflection screen for nighttime use; "on-off" information system; digital tachometer and PTO rev counter. The brake and clutch pedals are suspended. This allows the footboards to be free from obstacles. Inverter levers in "handy" position, on the tunnel for the TGF 9900 model and at the steering wheel for the TGF 10900 model.



AC TRACTOR

TRADITIONAL TRACTOR

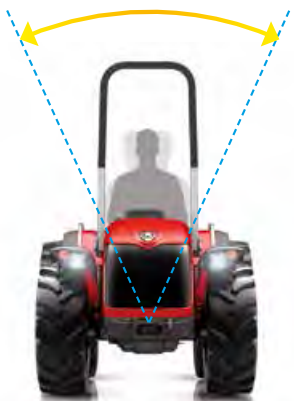

The lighting equipment, integrated into the mudguards, is comprised of reflecting parabolic optical assemblies, which offer a wide range of illumination covering the roadway, the equipment, and the surrounding field. The adjustable steering wheel allows any operator to find his ideal driving position. Maintenance is practical and fast thanks to the fact that the bonnet can be fully opened and the side panels and battery cover can be easily removed.



+ **Efficiency:** Reduced fatigue & increased tractor performance

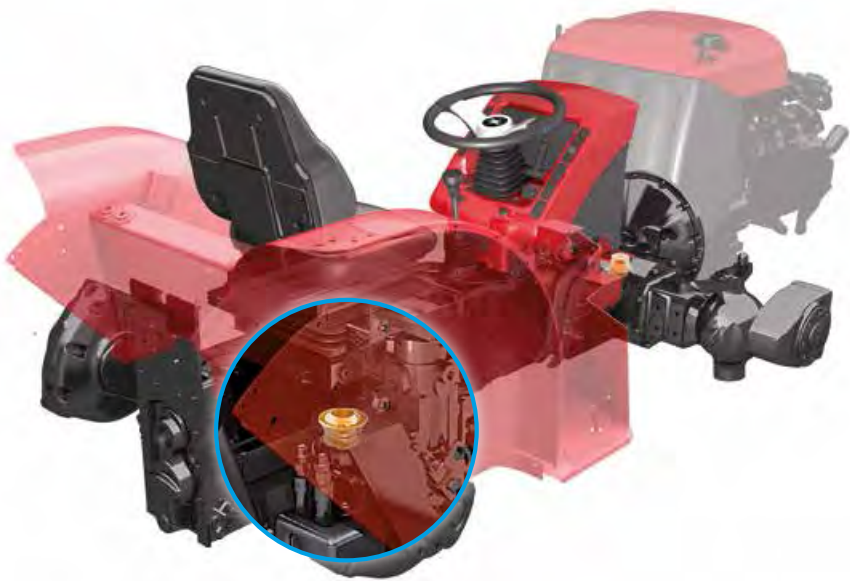

SILENT-BLOCK



MACHINE AND EQUIPMENT: an integrated technological system

The integrated lifting - hydraulic system - PTO assembly can mount a large variety of implements at both the front and rear. The lift is a single group with vertical cylinders, featuring a 3-point hitch. The rear lift controls the equipment precisely and optimizes the stability of the tractor allowing it to follow the contour of the terrain without slipping or sliding sideways.





Vertical hydraulic tie-rod and 3-point hitch* allow adjustments to be made from the driver's seat (for the model 10900).



The slider* tow hook with rapid vertical adjustment, is used to optimize the connection height of the towed equipment.



Two speed PTO: 540 rpm, 540 E (750 rpm) and synchronized with gear speeds.



The PTO shaft of the ASAE 1 3/8 type is the same for all speeds.



Hydraulic system with 1 double-acting manifold, 1 double-acting with floating position + 1 oil return tap. Total: 5 rear connectors.



The front lift* optimizes work combined with rear tools (for the model 10900).

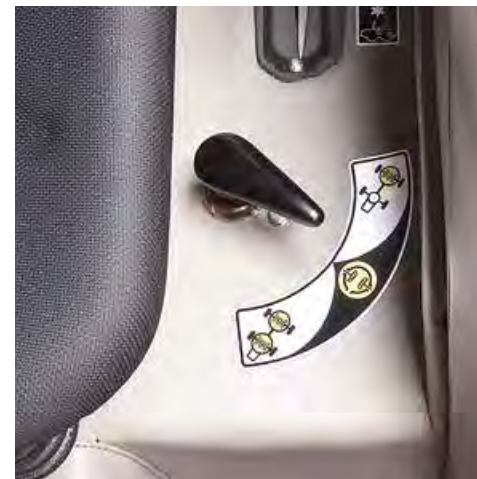

The rear differential lock prevents slipping and optimizes traction.

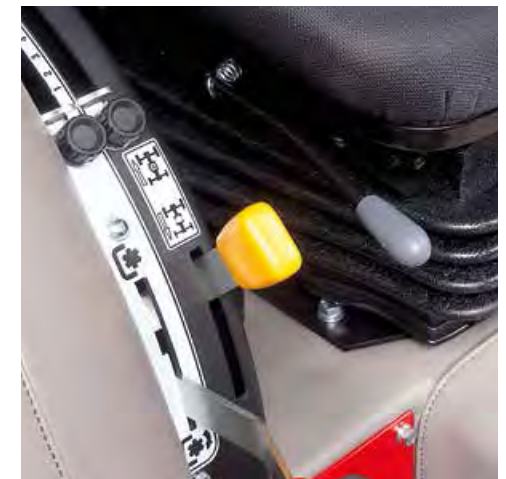

The front traction disengagement is useful when travelling along roads and prevents damage from being done to delicate grounds.

*optional

MACHINE AND EQUIPMENT: an integrated technological system

The front lift* optimizes combined processes such as a front grass shredder with a rear between-row mower, a front vine trimmer with a rear side-shoot remover, a front vine trimmer with a rear mulcher, or a front snow blade with a rear salt/sand spreader. The clutch of the PTO features an hydraulic progressive engagement command.

*optional only for the model 10900

PLUS

- + **Practicality:** engagement facilitated by the cardan shaft
- + **2 Speed PTO:** fuel saving
- + **Comfort:** the PTO can be engaged while the tractor is moving
- + **Efficiency:** less heat build-up
- + **Functionality:** engagement without stalling the engine
- + **Lifetime:** safeguard of PTO shaft
- + **Comfort:** less operator stress



OPTIONAL



BULLBAR

Tubular steel guard protecting the bodywork; integrates the third-point for the front lift.



FRONT BALLAST

Perfectly integrated into the bodywork of the tractor; it does not alter the wheelbase or dimensions of the tractor.



HEADLIGHT GRILLES

Protecting the light assemblies, they also make the bodywork look more appealing.



SLIDER HOOK

Integrated into the rear lift, it gives the operator various options for the practical setting up of the tractor and the rapid alignment of the towed equipment.



ADJUSTABLE BARS

Rear 3-points linkage with adjustable bars and quick couplings.



FRONT LIFT

Used together with the bullbar and 1 double-acting distributor, it allows all the frontal equipment to be used.



FABRIC GRAMMER* SEAT

Air suspension with load display - reclining backrest - lumbar support.



PNEUMATIC SEAT

Pneumatic suspension seat with height regulation and automatic driver-weight adjustment (from 50 kg to 130 kg).



REAR CAST IRON WHEEL FLANGES

Flanges that increase the weight of the tractor at the rear.

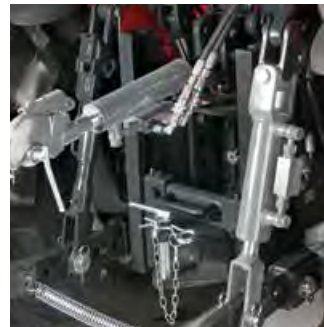

VERTICAL TIE-ROD AND HYDRAULIC THIRD-POINT

Optimizes the positioning and inclination of the equipment.



RAPID REAR COUPLINGS

Vertical tie-rods + hydraulic third hitch > 4 rear independent mini couplings

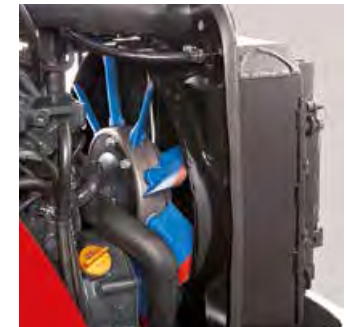

CLEAN FIX™ system

Reverse flow fan that assures the constant cleaning and efficiency of the radiator and of the front grille of the bonnet.

CAB: "StarLight"



This original and approved AC product features a spherically curved, simple and essential design. The airtight seals and integrated hinges allow the "StarLight" cabin to enter the narrowest rows without damaging flowering plants or fruit. The front and rear windows offer full visibility of equipment and the roadway. The ventilation system features a rapid front windscreen defogging system.

The acoustic comfort on board the "StarLight" is similar to that of a car due to the internal layer of sound-absorbing material on the cabin walls. "StarLight" features a car radio*, a removable license-plate holder, and adjustable rear-view mirrors.



The incoming air is cleaned by a large filter, with an available activated carbon filter.



The air-conditioning is achieved by a powerful system running on R134A ecological coolant, which also refreshes the cabin air using a low rev motor. The heating system utilizes a powerful heat-exchanger which is most exceptional even in the coldest weather.



Front and rear working lights assembled in the cab roof and foldable number plate holder.



Cabin controls (windshield wipers, work lights, rotating beacon) in an ergonomic position, even when reversing.



The panoramic roof with sunblind and full glass doors offer full top and side visibility.



Easy access to the driving position with all-around visibility.

**COMFORT
VISIBILITY
SAFETY**

StarLight



PROTECTOR 100: the only certified compact cab

The **AC super-low profile Protector100** cabs (minimum h 1740 mm / 68.5 in) were designed to protect operators while working on crops that are difficult to access, such as sloping rows or crops planted on steep slopes, but also to isolate them from the external ambient during treatment with plant protection products. The hermetic seal and controlled pressurization guarantee a healthy workplace free of toxic fumes.

Despite its compact size, Protector100 provides easy and obstacle-free access. All the controls are ergonomically positioned in a logical sequence. All-around visibility is assured by the glass doors and the rear window, which also allows the operator to see the equipment.

The "butterfly" profile steel frame with continuous radius of curvature makes for a racy profile with no projecting elements. The two inspection windows in front of the driver's legs make the tires and roadway visible during operation. Protector100 is fitted for a car radio, cigarette lighter, rear lights integrated into the roof, and foldable beaconlight support.

The pressurized **Protector 100** cab combines superior comfort and visibility, while protecting the operator from toxic fumes when using pesticides. The cab sealing and pressurization are monitored by the Air Control system, a liquid crystal digital display located on the driver's console.

PROTECTION
DIMENSIONS
HEALTH



PROTECTOR 100

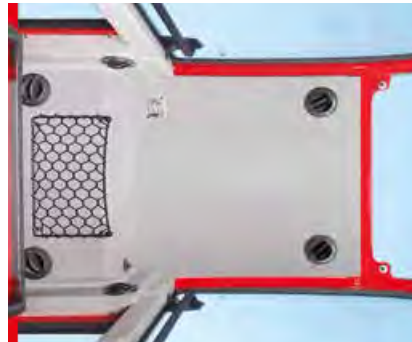

The air-conditioning is achieved by a powerful system running on R134A ecological coolant, which also refreshes the cabin air using a low rev motor. The heating system utilizes a powerful heat-exchanger which is most exceptional even in the coldest weather.

Customers can choose between three cab options: Protector S, the super-low profile Cat. 1 cabin, Protector 100 with Cat. 1 certified pressurization system (protection against dusts and pollens, electronic climate control) or **Protector 100 with Cat. 4 certified pressurization system** (protection against dusts, aerosols and vapours, electronic climate control).



Note: Antonio Carraro super low profile cabs are the only compact cabs with Cat. 4 certification currently available on the market.



Rear working light assembled in the cab roof and foldable rotating light holder.



Air Control system, a liquid crystal digital display located on the driver's console that constantly records the pressurisation parameters within the cab showing the internal pressure values and the hours of operation of the **Cat. 4** activated carbon filters.



Large filters with quick and immediate access for ordinary maintenance.



TRANSMISSION AND GEARS: many speeds in a logical sequence

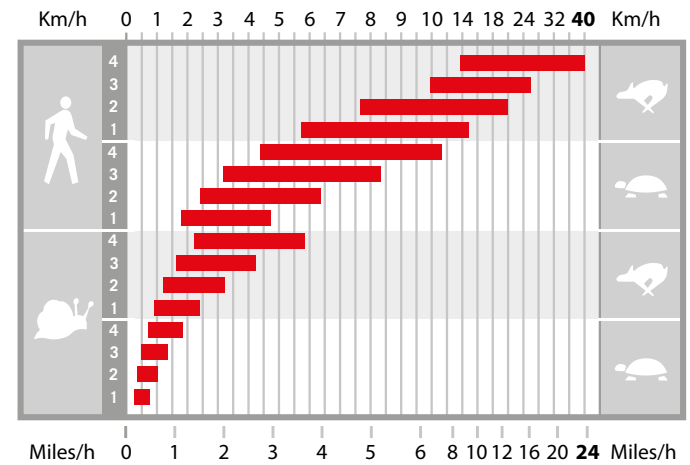

The tractors in the Ergit 100 series utilize large, extraordinarily reliable, smooth engaging clutches that do not require adjustment thanks to the hydraulic control, which recovers the play caused by wear over time.

The gear has a helical profile: 32 speeds, 16 FW and 16 RV, with a synchronized inverter that can be engaged even when the tractor is moving. The small gap between one gear and the next assures operative continuity in all circumstances.



- + **Reliability:** long lifetime of the clutch
- + **Efficiency:** wide range of speeds
- + **Comfort:** smooth engagement without jerking the engine
- + **Saving:** lower fuel consumption and reduced running costs

e-DRIVE TRANSMISSION: maximum ease of driving

The new transmission houses the e-DRIVE system complete with synchronizer assembly, servo controls and range shift and reverse shuttle control unit.



e-DRIVE RANGE SHIFTING*

The driver can shift through the speed ranges comfortably and without effort at the simple touch of a button.



e-DRIVE REVERSE SHUTTLE*

The *e-DRIVE* reverse shuttle with control lever under the steering wheel comes in handy for operations involving back and forth movements in rapid succession, such as loading and unloading of material with forklifts, loaders or snow blades. The driver is assisted by an electronic system, which enables him to operate the tractor under the safest conditions without ever taking his hands off the steering wheel.

*optional only for the model 10900



ENGINE: powerful and quiet

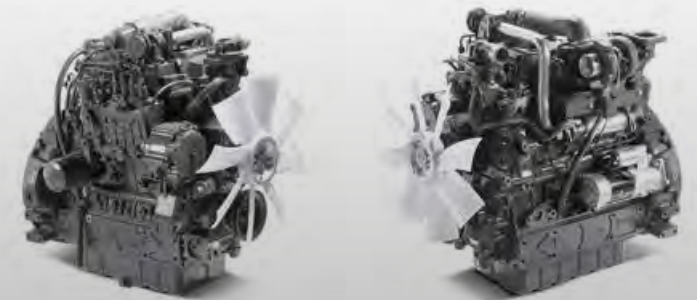

TGF 9900	TGF 10900
Diesel direct injection with counter rotating weight system	
Stage 3A emissions regulations	
4 - 16 Valves • Turbo	
89 HP	99 HP

The engines are at the top of their category and offer unbeatable torque and power performance as well as lower fuel consumption, lower noise, and lower carbon emissions. All the engines comply with "STAGE 3A" standards which limit the harmful emissions of diesel engines. Thanks to this new generation of engines, the company has achieved new goals in terms of efficiency and cost-effectiveness.



- + **Reliability:** quality of components
- + **Performance:** maximum efficiency
- + **Comfort:** minimum vibrations, noise, and emissions
- + **Saving:**
 - € less maintenance costs
 - € rapid amortisation
 - € lower fuel consumption



TGF: the specialized tractor par excellence

**SPECIALIZATION
COMPACTNESS
RELIABILITY**





**SMARTNESS
PROFITABILITY
UNIQUENESS**





SAT: Customer Service Team



RICAMBI ORIGINALI
GENUINE SPARE PARTS

Antonio Carraro® Original Spare Parts and Assistance

The AC dealer network utilizes modern equipment and instruments that have been especially designed and built for maintenance work on AC tractors. The technicians at every authorised dealership periodically attend technical training courses at the Parent Company's facilities. Each authorised workshop employs highly qualified staff and provides an extensive range of services in order to offer its Customers maximum peace of mind and total protection. AC dealers can give their Customers information on all the services related to the care of AC tractors.



EXG MAXIMUM PROTECTION: 4 years without worries!

As a proof of its reliability, Antonio Carraro offers, in addition to its two-year standard warranty, an extension of warranty coverage up to three or four years, called **EXG Maximum Protection**. At the time of purchase or within the first 24 months of the tractor's life (during which all scheduled maintenance services must be performed as recommended in the AC Use and Maintenance Manual), Customers may apply for either a three- or four-year extended warranty, according to their needs. Whatever coverage they choose, Customers are recommended to have all service performed at any of the **authorised locations of our global dealer network**, where repairs will be carried out by highly qualified personnel using only **AC Original Spare Parts**. In case of sale of the tractor, the warranty coverage may be transferred to the new owner.

After-sales service

Thanks to the capillary network of dealers and the competence of the Service Managers, the Parent Company can assure all-around skills. With the right maintenance work, every AC tractor will continue to provide excellent performance throughout its operating lifetime.



Original Antonio Carraro Spare Parts

Original Antonio Carraro Spare Parts is a registered trademark. The elevated standards of design and the stringent tests carried out during the entire production process assure maximum quality levels. With Original AC Spare Parts, Customers can be certain of maintaining tractor performance unaltered over time, thus preserving the safety and the value of the tractor.



TECHNICAL DATA: TGF

THE
ERGIT 100
SERIES

Model	TGF 9900	TGF 10900
Chassis	"ACTIO™" – Full chassis with oscillation • Steering wheels • 4 unequal wheel drive • Front and rear final drive	
Engine Type	Kubota • Diesel direct injection with counter rotating weight system	
Emissions Regulations	Stage 3A	Stage 3A
N° Cylinders	4 - 16 Valvole • Turbo	4 - 16 Valvole • Turbo
Displacement (CC)	3769	3769
Power kW/HP (97/68/CE)	65/89	73/99
Maximum engine revs	2600	2600
Torque max (Nm/revs)	285/1600	320/1600
Cooling	Water	Water
Tank Capacity (litres/gal):	60/15.85	60/15.85
Transmission	Synchronized 32 speed gear box: 16 forward and 16 reverse with synchronized inverter	
Inverter lever	On the tunnel	At the steering wheel
PTO	Rear, independent and synchronized at 540/540E rpm with progressive hydraulic engagement	
Shaft	Profile 1" 3/8 with 6 splines with facilitated engagement	
Transmission clutch	Hydraulic control	
Drive disengagement	Hydraulic control on the front	
Hydraulic system:		
Double acting distributor	No. 1 floating position + oil reflow	No. 2 (1 floating position) + oil reflow
Oil pumps	No. 1 with load sensing circuit	No. 2 with independent circuits
Rear hydraulic lift	With 3 point hitch	Draft and position control with 3 point hitch
Operating Pressure (bar/psi)	160/2320	
Capacity (Kg/lbs)	2400/5291	
Steering	Hydraulic with 2 pistons	
Brakes	Standard: hydraulic front and rear disk brakes in oil bath, rear steering brakes Independent emergency and parking brake: band type on transmission	
Platform	Suspended on Silent Block	
Weight in order of speed:		
With roll bar (Kg/lbs)	2230÷2410 / 4916÷5313	2230÷2410 / 4916÷5313
With Protector cab (Kg/lbs)	2240÷2520 / 4938÷5555	2240÷2520 / 4938÷5555
With Starlight cab (Kg/lbs)	2320÷2460 / 5115÷5423	2320÷2460 / 5115÷5423

STANDARD FEATURES

Rear or front/rear differential lock with hydraulic control • Adjustable steering wheel • Lift arms fix type with coupling balls group 1 and 2 • Adjustable, suspension seat with safety belt • Foldable protection roll bar • Adjustable wheel rims • 2 lever ancillary rear hydraulic system • Rear adjustable height tow hitch • Front tow hitch • Multifunctional digital instrument Km/h and PTO • Battery • Battery isolation switch • Electrical power point • Safety starting device on the inverter and PTO • Rear working light (mod. 10900)

OPTIONAL FEATURES mod. 9900/10900

• "StarLight" cab suspended on Silent Blocks, soundproof, with heating and air conditioning system and window on the roof; activated carbon filter on request • "PROTECTOR 100" cab suspended on Silent Blocks, soundproof, with heating and air conditioning system; "Digital Air Control", a digital control of cab pressurization with Cat. 1 certified or with Cat. 4 certified • Support with six front ballast weights • Front power lift • Adjustable lifting arms with quick release couplings • Pneumatic suspension seat with height regulation and automatic driver-weight adjustment • Slider tow hitch • Pair of front/rear ballasts • Cast iron wheel flanges for 20" and 24" rear wheels • Front bullbar • Front lamp guards

Only on mod. 9900

"PROTECTOR S" cab suspended on Silent Blocks with heating and air conditioning system, Cat. 1 certified • Hydraulic power lift with draft and position control • Rear working light

Only on mod. 10900

Electrohydraulic e-DRIVE transmission with reverse shuttle under the steering wheel and range shift • Fabric Grammer seat - air suspension with load display - reclining backrest - lumbar support • Hydraulic third hitch and vertical tie-rod with electro-hydraulic control with quick couplings • 4 front hydraulic outlets • Front power lift • Clean FIX™ > reverse flow fan for constant cleaning of the radiator and of the front grille of the bonnet • Hydraulic brake for trailer



DIMENSIONS TGF

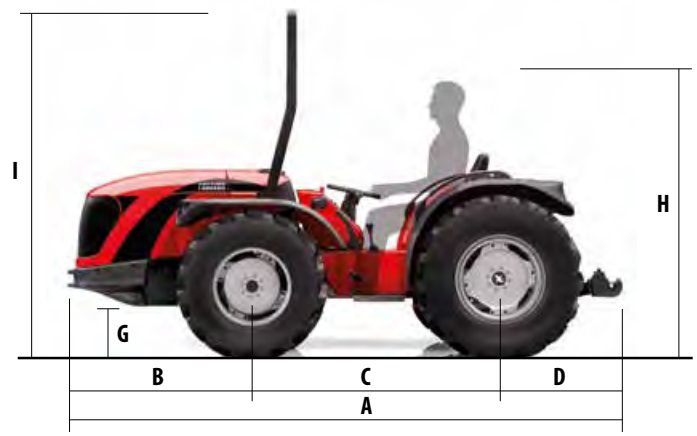

Front wheels

			E					
8.25-16	250/80-16	300/80-15.3	280/70 R18	260/70 R16	320/65 R18	320/70 R20	400/55-22.5 Twin	
E 230/9.05	250/9.84	300/11.8	320/12.6	260/10.2	320/12.6	320/12.6	400/15.7	

Rear wheels

280/85 R20	320/70 R20	360/70 R20	360/70 R20	340/65 R18	420/65 R20	360/70 R24	500/60-22.5 Twin
E 275/10.8	320/12.6	360/14.2	420/16.5	340/13.4	420/16.5	360/14.2	500/19.7

Wheels

Dimensions (mm/inch)

Front	Rear	A	B	C	D	F	G	H**	I	L*	M	N*	O	P
8.25-16	280/85 R20	3555/140	1225/48.2	1530/60.2	800/31.5	2070/81.5	255/10.0	1747/68.7	2325/91.5	1330/52.3	1100/43.3	1325/52.1	1050/41.3	1810/71.2
250/80-16	320/70 R20	3555/140	1225/48.2	1530/60.2	800/31.5	2070/81.5	255/10.0	1747/68.7	2325/91.5	1385/54.5	1145/45.1	1370/53.9	1050/41.3	1810/71.2
300/80-15.3	360/70 R20	3555/140	1225/48.2	1530/60.2	800/31.5	2090/82.3	275/10.8	1767/69.5	2345/92.3	1470/57.9	1170/46.0	1415/55.7	1060/41.7	1830/72.0
280/70 R18	360/70 R20	3555/140	1225/48.2	1530/60.2	800/31.5	2090/82.3	275/10.8	1746/69.5	2345/92.3	1420/55.9	1170/46.0	1415/55.7	1060/41.7	1830/72.0
260/70 R16	340/65 R18	3555/140	1225/48.2	1530/60.2	800/31.5	2000/78.7	185/7.28	1677/66.0	2255/88.7	1380/54.3	1120/44.1	1595/62.8	1250/49.2	1740/68.5
320/65 R18	420/65 R20	3555/140	1225/48.2	1530/60.2	800/31.5	2090/82.3	275/10.8	1767/69.5	2345/92.3	1460/57.5	1140/44.9	1550/61.0	1130/44.5	1830/72.0
* 320/70 R20	360/70 R24	3555/140	1225/48.2	1530/60.2	800/31.5	2145/84.4	330/13.0	1822/71.7	2400/94.5	1460/57.5	1140/44.9	1475/58.1	1120/44.1	—
* 400/55-22.5	500/60-22.5	3555/140	1225/48.2	1530/60.2	800/31.5	2145/84.4	330/13.0	1822/71.7	2400/94.5	1610/63.4	1210/47.6	1660/65.3	1160/45.6	—

* Wheels not available with Protector cab

* Min. external width

** Height calculated with the operator of average height sitting (cm/in 175/68.9)

The description and illustrations in this brochure are provided simply for information purposes; they are not binding and may be varied at any time without notice.



DEALER:



ANTONIO CARRARO SPA
Via Caltana, 24
35011 Campodarsego Padova ITALY
info@antoniocarraro.it
antoniocarraro.com

COD. 47318 130 - 02/2016